

TT 11 rail 12V DC (0.27 kW)

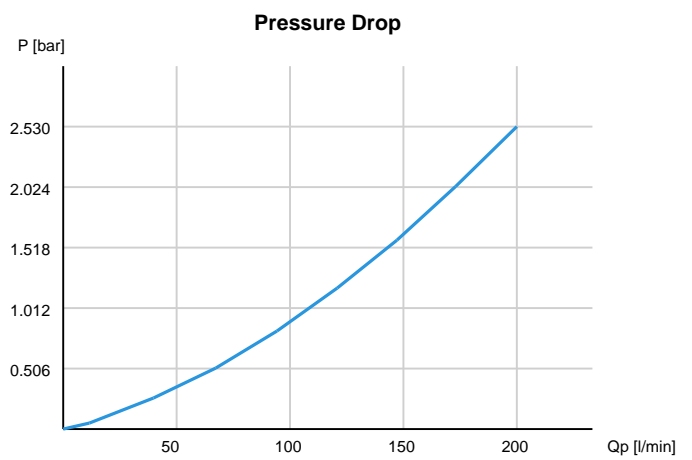

A:	340 mm	J:	100 mm
B:	380 mm	K:	360 mm
C:	-	L:	175 mm
D:	255 mm	N:	6
G:	-	W:	-

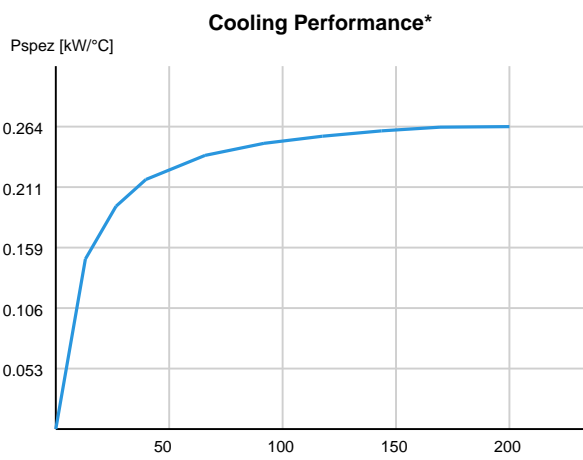

TT 11 rail 12V DC (0.27 kW)

Order Number	Motor Power	Current	Protection Level	Rotation	Air Flow	Noise Level	Weight
ASATT11RD01	0.27 kW	20.8 A	IP 68	-	0.62 kg/s	77 db(A)	8.7 kg



Working pressure (static): 26 bar
Radiator material: Aluminium

TT 11 rail 24V DC (0.27 kW)

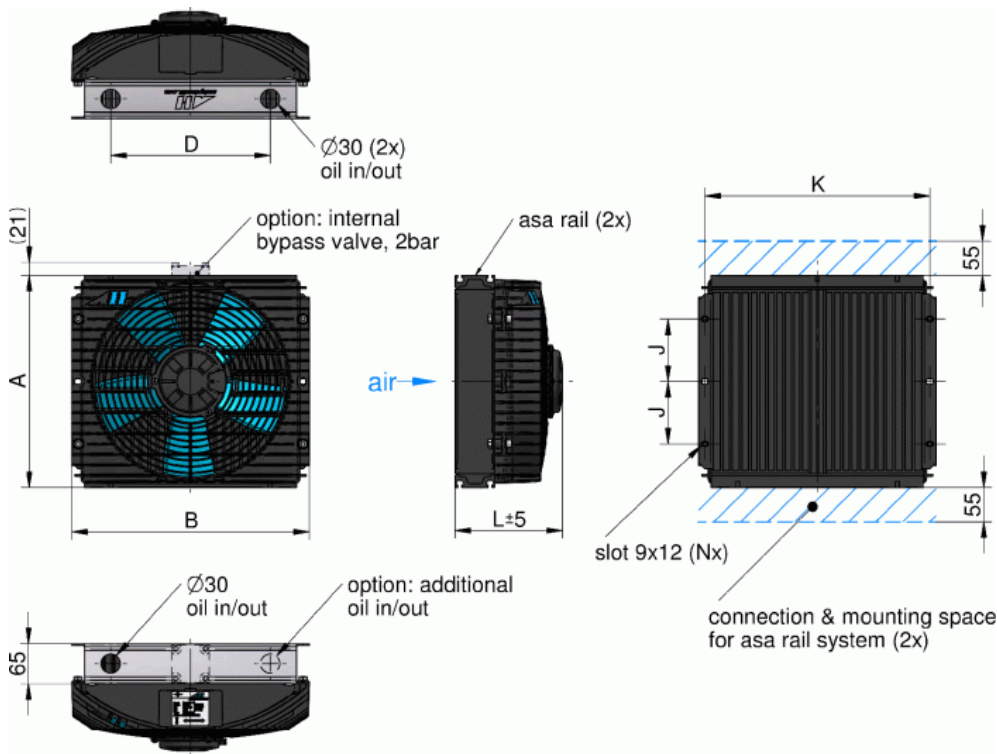

A:	340 mm	J:	100 mm
B:	380 mm	K:	360 mm
C:	-	L:	175 mm
D:	255 mm	N:	6
G:	-	W:	-

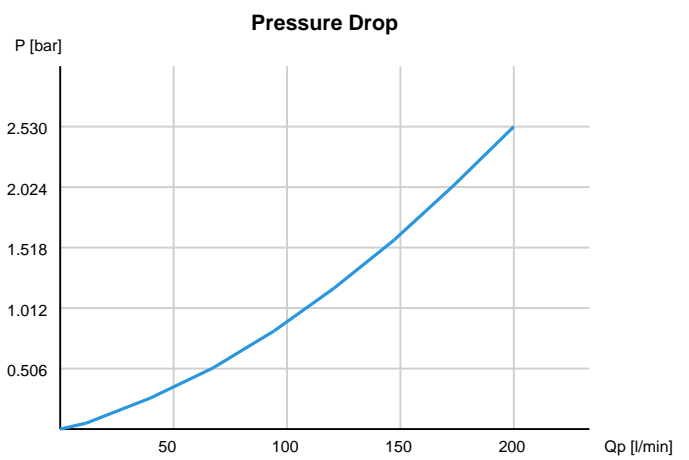
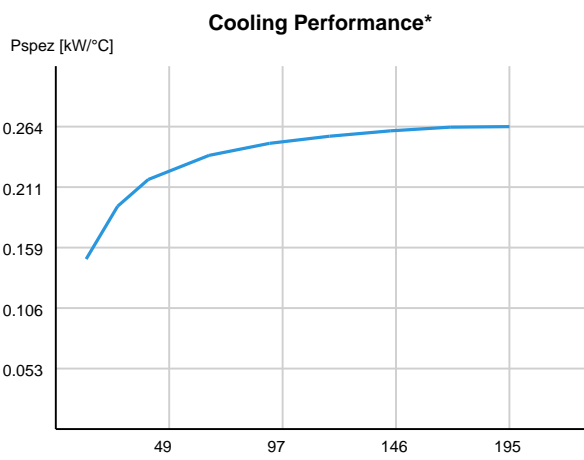

TT 11 rail 24V DC (0.27 kW)

Order Number	Motor Power	Current	Protection Level	Rotation	Air Flow	Noise Level	Weight
ASATT11RD02	0.27 kW	10.4 A	IP 68	-	0.62 kg/s	77 db(A)	8.7 kg



Working pressure (static): 26 bar
Radiator material: Aluminium

***Note - Cooling Performance**

The cooling performance mentioned in this homepage is conservative and measured at a test bench according to asa test procedures with oil type ISO VG 46 and presents a bases for your cooler selection regarding required cooling performance. Because there is no standard test procedure, tests used by other manufacturers might have different results. Due to different environment conditions the cooling performance can vary by +/- 15%.

Therefore we recommend all coolers be checked under the system operating conditions. This is also true for vibrations and mechanical stress as well as for pressure peaks and thermal stress.

General tolerance according to DIN 2768-v.

The information contained in this homepage is intended to be used as a guideline only. Customers should always confirm the suitability of the information and these products in their particular applications. ASA assumes no liability for any errors, commissions or misprints and reserves the right to change products and details without prior notification. As we are constantly improving our products, the characteristics, dimensions and weights can also change, although we do our best to incorporate these changes continually.

asa hydraulik GmbH
Prager Strasse 280
A-1210 Wien, Austria, Europe

Tel.: ++43 / 1 / 292 40 20
Fax: ++43 / 1 / 292 40 70

support@asahydraulik.com
www.asahydraulik.com